



# Capex & Cresfinex

Maintenance Free  
Roofing System

Bay Plastics Ltd

Unit H1 High Flatworth

Tyne Tunnel Trading Estate

North Shields

Tyne & Wear

NE29 7UZ

Tel: +44 (0) 191 258 0777

Fax: +44 (0) 191 258 1010

Email: [sales@bayplastics.co.uk](mailto:sales@bayplastics.co.uk)

All Exitex roofing systems are manufactured to the highest standards, incorporating many unique patented features.



## Contents

---

● Capex 50 & 70	4
● Capex 40 & 60	6
● Cover Caps & Hip Bars	8
● Capex & CFX for Gable End Roofs	9
● Roof Light Detail	10
● CFX MK3 Ridge	11
● Cresfinex Ridges	12
● Ankorglaze	13
● Horizontal Glazing Bar	14
● Valleys	15
● Additional Components	16
● Capex & Cresfinex Components	17
● Gasket, Accessories & Elaso-O-Sealant	23
● Capex Snap Down	26

Capex 50, 70 & CFX MK4 Ridge

- |          |   |          |  |
|----------|---|----------|--|
| <b>A</b> | Full range of finials in aluminium or uPVC      | <b>I</b> | Horizontal glazing bar                     |
| <b>B</b> | CFX snap cover (when not fitting crests)        | <b>J</b> | Cresfinex bridgings 50 or 70               |
| <b>C</b> | Full range of crests in aluminium or uPVC       | <b>K</b> | Hip bridgings 50 or 70                     |
| <b>D</b> | Aluminium cresfinex wall end cap                | <b>L</b> | Extended end caps in aluminium or uPVC     |
| <b>E</b> | Capex wall flashing profile 50 or 70            | <b>M</b> | Hip bar 70                                 |
| <b>F</b> | Cresfinex MK4 ridge                             | <b>N</b> | Hip jack cap 70                            |
| <b>G</b> | Ankorglaze with or without condensation control | <b>O</b> | Cresfinex MK4 radius end cap               |
| <b>H</b> | Capex concealed fixing 50 or 70                 | <b>P</b> | CFX cap and cap (when not fitting finials) |

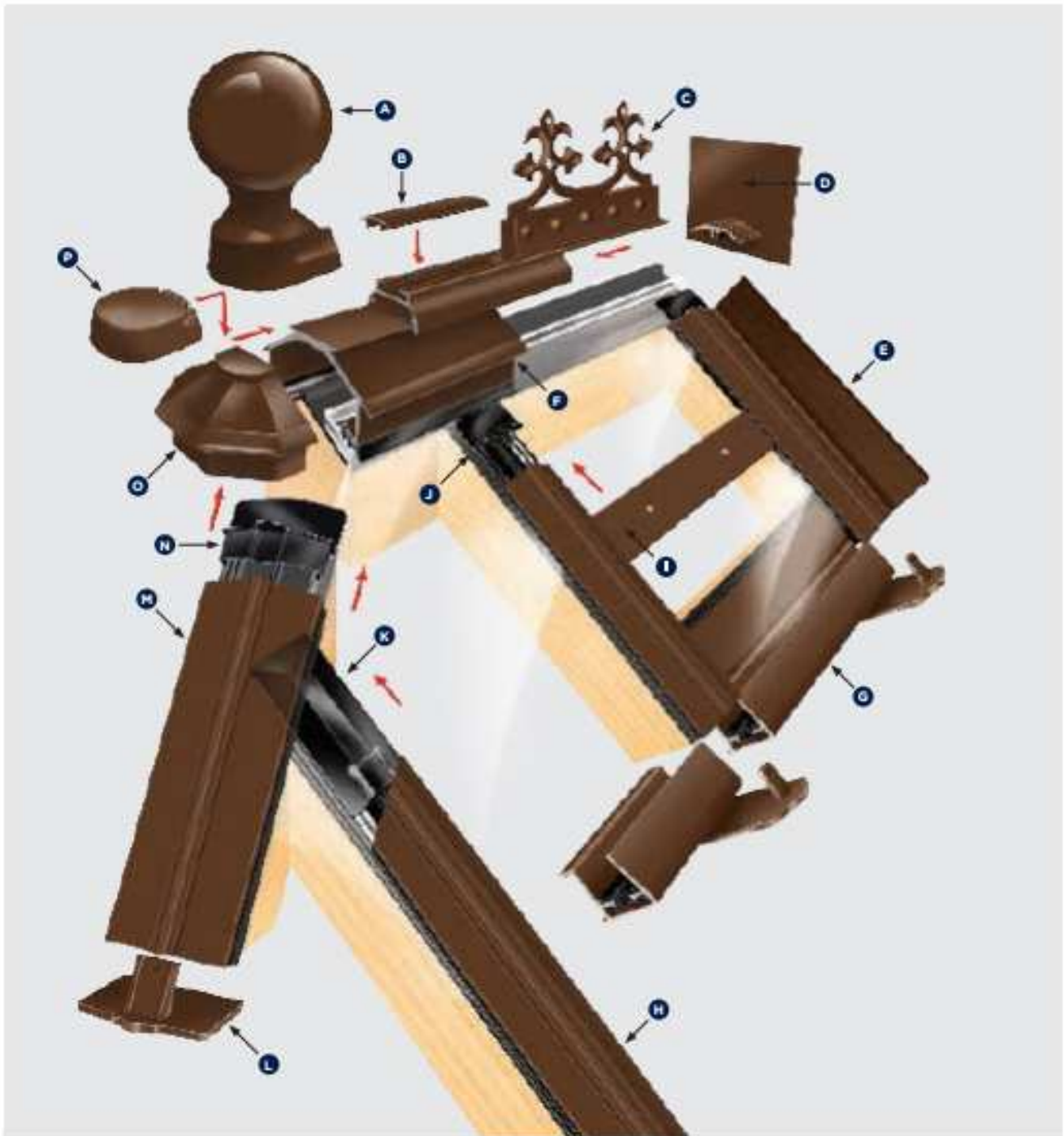



**Capex 50 for rafters up to 50mm**

Concealed Fixings

Concealed Gaskets

Available in 2.4, 3, 4.8 & 6m

Colours - Wh Ral 9010, Bn Ral 8040, Mill Finish

Rag 45 rafter gasket available separately

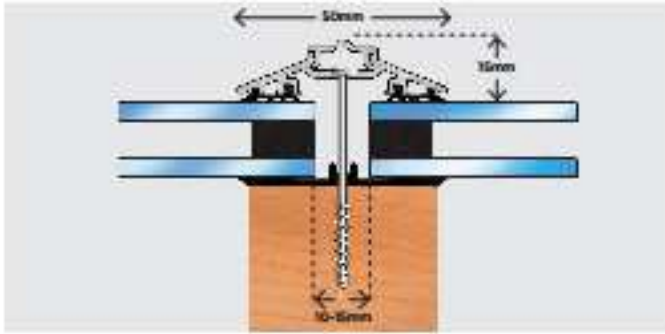

**Capex 70 for rafters over 50mm**

Concealed Fixings

Concealed Gaskets

Available in 2.4, 3, 4.8 & 6m

Colours - Wh Ral 9010, Bn Ral 8040, Mill Finish

Rag 55 rafter gasket available separately

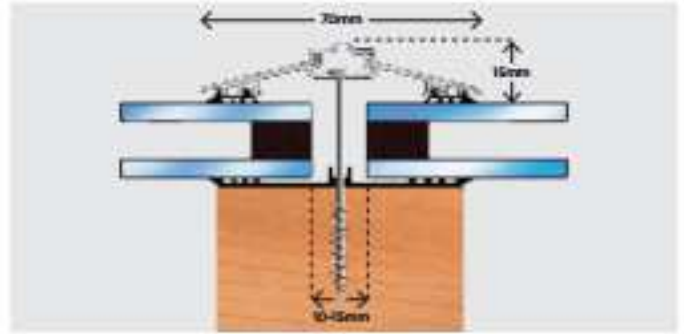

**Capex 50 gable end finishing profile**

Available in 3 & 6m

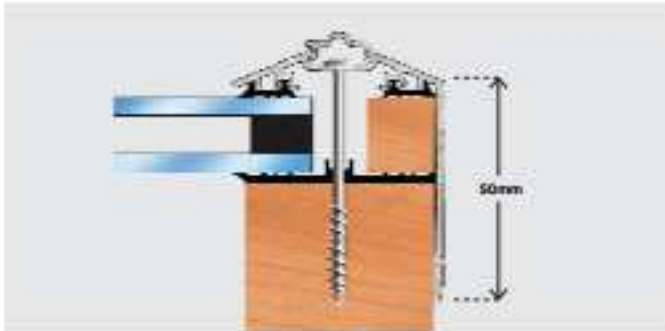

**Capex 70 gable end finishing profile**

Available in 3 & 6m

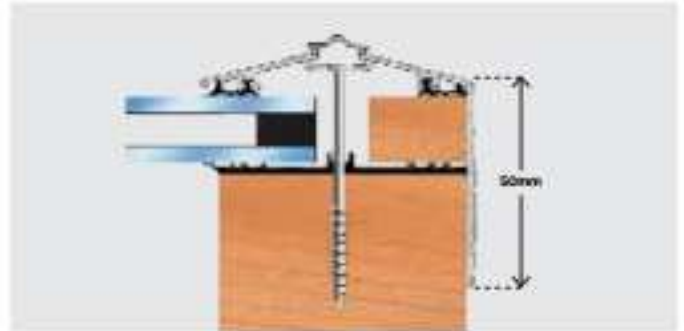

**Capex 50 wall flashing profile**

Available in 3 & 6m

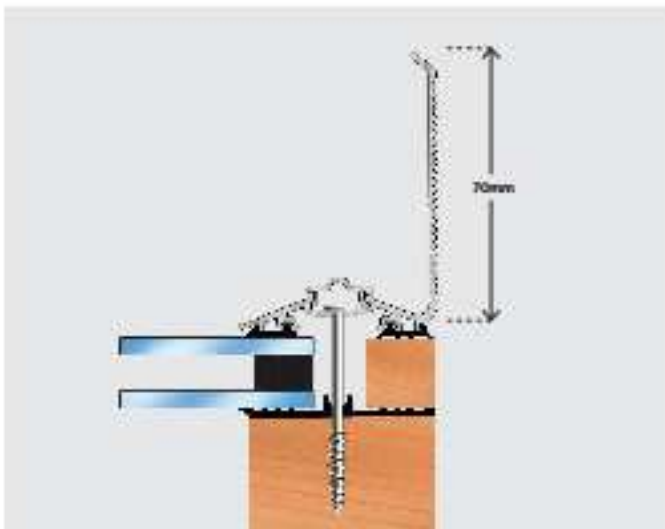

**Capex 70 wall flashing profile**

Available in 3 & 6m

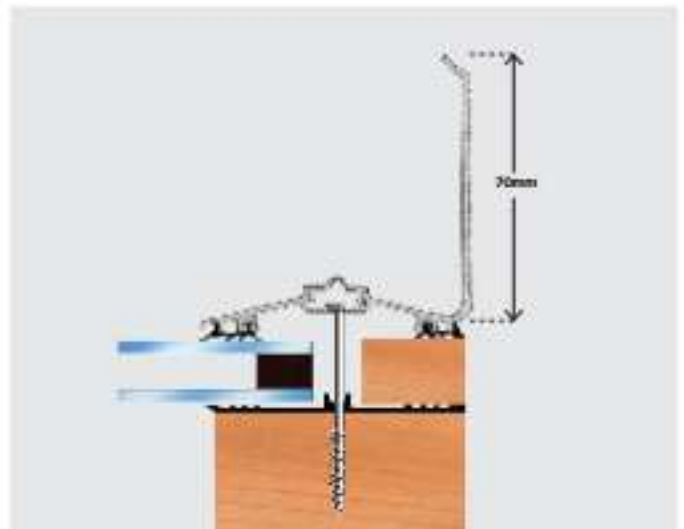

Capex 40, 60 & CFX MK2 Ridge

**A** CFX cap end cap (when not fitting finials)

**B** CFX/M2 radius endcap

**C** Full range of finials in aluminium or uPVC

**D** CFX snap cover (when not fitting crests)

**E** Full range of crests in aluminium or uPVC

**F** Aluminium cresfinex wall endcap

**G** Capex wall flashing profile 40 or 60

**H** Ankorglaze with or without condensation control

**I** Capex 60 with H/V gasket

**J** Extended end cap in uPVC

**K** Jackcap 40 or 60

**L** Capex H/V bridging 40 or 60

**M** Capex 40 or 60

**N** CFX/M2 ridge

**O** CFX/BDG 40 or 60



**Capex 40 for rafters up to 50mm**

Available in 2.4, 3, 4.8 & 6m

Colours - Wh Ral 9010, Bn Ral 8040, Mill Finish

Rag 45 rafter gasket available separately

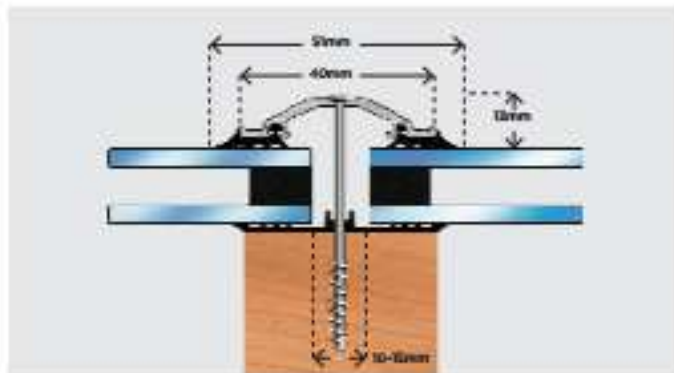

**Capex 60 for rafters over 50mm**

Available in 2.4, 3, 4.8 & 6m

Colours - Wh Ral 9010, Bn Ral 8040, Mill Finish

Rag 55 rafter gasket available separately

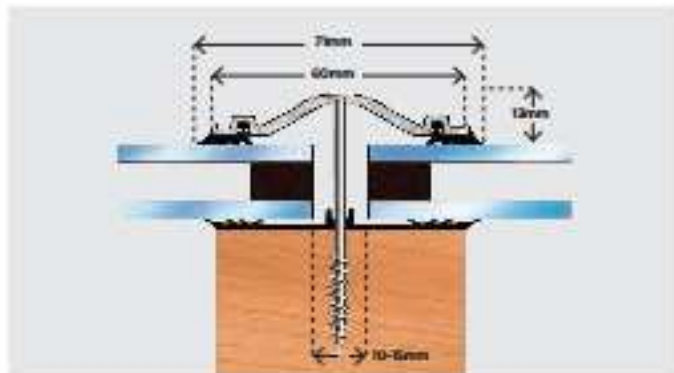

**Capex 40 gable end finishing profile**

Available in 3 & 6 metres



**Capex 60 gable end finishing profile**

Available in 3 & 6 metres

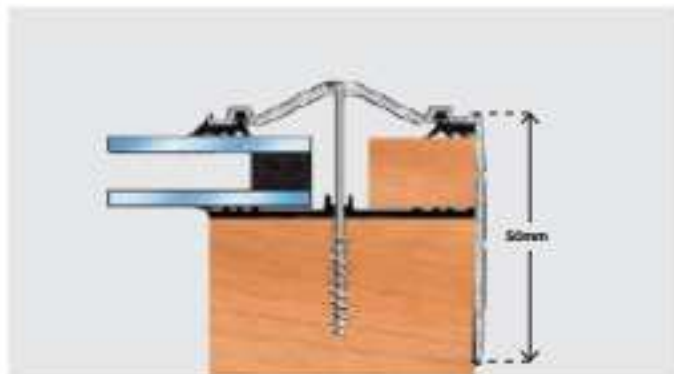

**Capex 40 wall flashing profile**

Available in 3 & 6 metres



**Capex 60 wall flashing profile**

Available in 3 & 6 metres

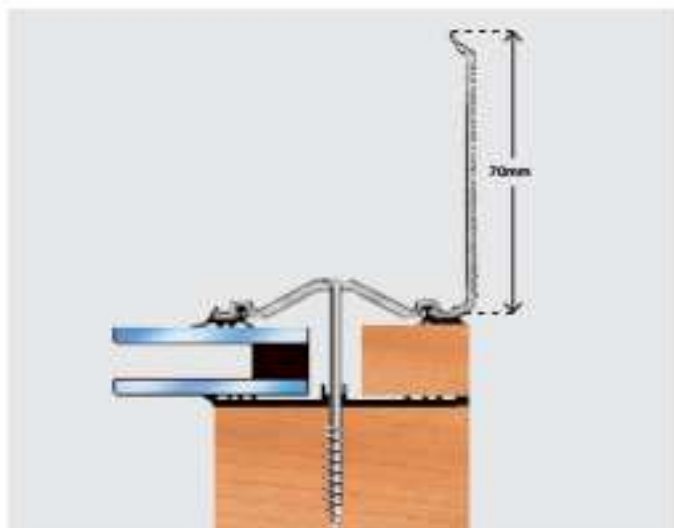



# Cover Caps & Hips Bars

## Capex 40 cover caps

Concealed Fixings

Available in 3 & 6 metres

**A** Capex 40 cover cap

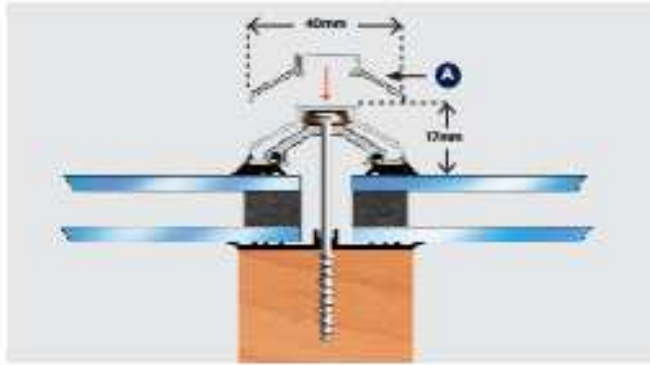

## Capex 60 cover caps

Concealed Fixings

Available in 3 & 6 metres

**A** Capex 60 cover cap

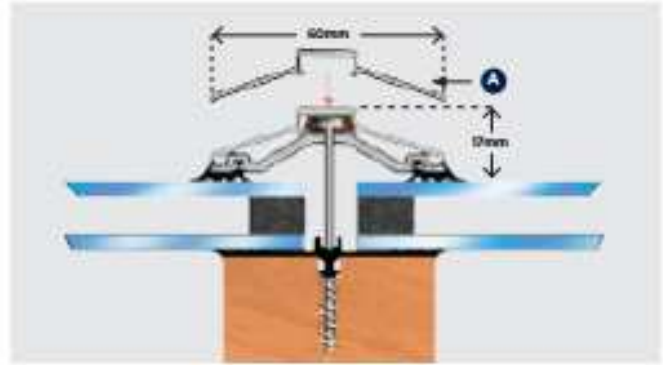

## Capex 60 with hip gasket

For roof pitches 15° - 50°

**A** Capex 60

**B** Hip and valley gasket

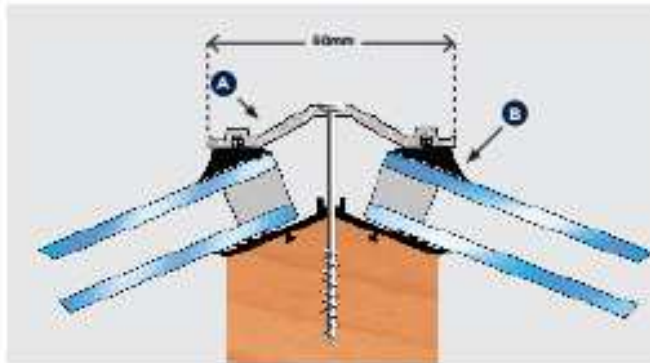

## Capex 60 with valley gasket

For roof pitches 15° - 50°

**A** Capex 60

**B** Hip and valley gasket

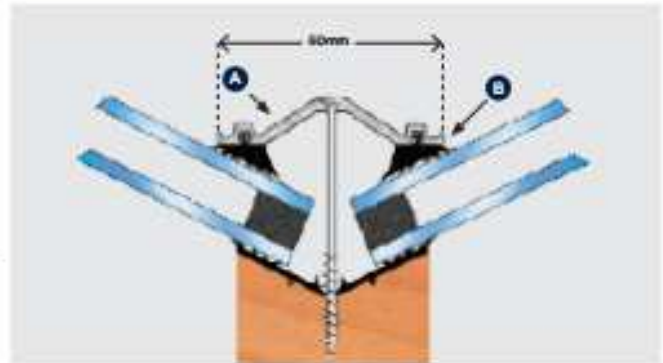

## Hip cover cap 60

Concealed Fixings

For roof pitches 15° - 50°

Available in 3 & 6 metres

**A** Hip cover cap

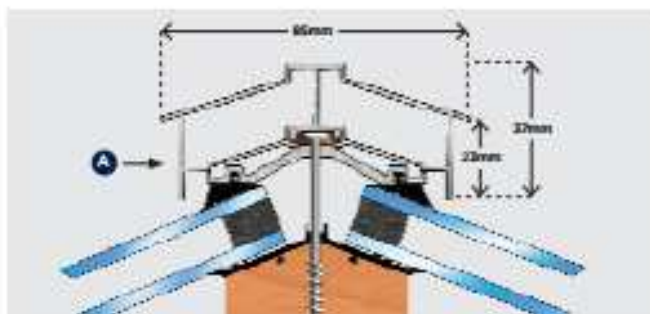

## Capex/70 hip bar

Concealed Fixings

For roof pitches 15° - 50°

Available in 2.4, 3, 4.8 & 6 metres

**A** Capex 70 hip bar

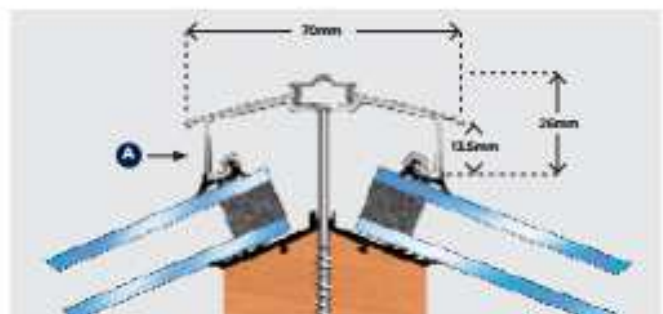



## Capex & CFX for Gable End Roofs

### Capex & CFX for gable end roofs

- A** Full range of finials in aluminium or uPVC
- B** CFX snap cover (when not fitting crests)
- C** Full range of crests in aluminium or uPVC
- D** Aluminium crestline wall end cap
- E** Capex wall flashing profile 50 or 70
- F** Ankorplaze with or without condensation control

- G** Extended end cap in aluminium or uPVC
- H** Capex 50 or 70 gable end flashing profile
- I** CFX MK2 and MK4 gable end cap
- J** CFX MK4 ridge
- K** CFX/BDG 50 or 70
- L** Capex concealed fixing 50 or 70



# Roof Light

## Roof light detail



## Vertical section through window

- A** Capex extended endcap
- B** Capex bridging
- C** Capex
- d** Flashing

- E** CFX ridge
- F** Aquatex
- G** Ankorglaze

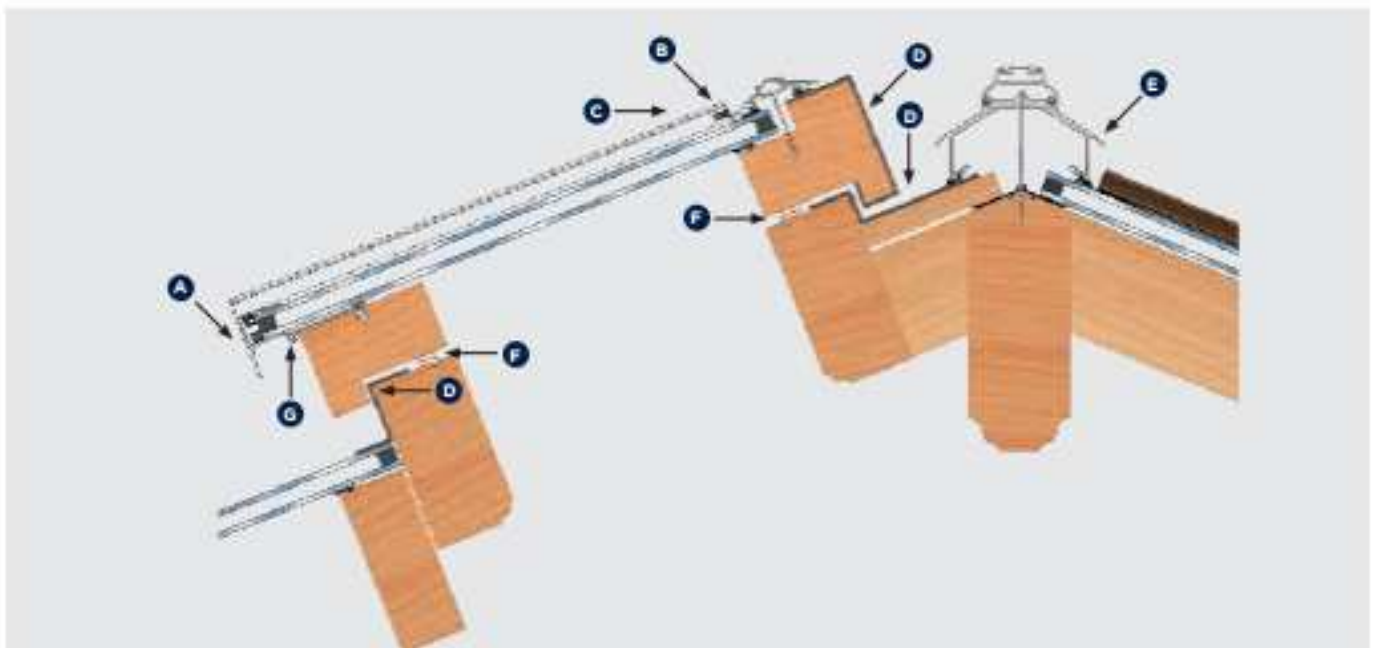

# Cresfinex MK3

## Ridge

### CFX MK3 Ridge

<b>A</b>	Bolt down tulip finial	<b>J</b>	Capex H/V bridging 40 or 60
<b>B</b>	Bolt down ball finial 125mm	<b>K</b>	Hip cover cap
<b>C</b>	Full range of crests in aluminium or uPVC	<b>L</b>	Capex 60 with H/V gasket
<b>D</b>	Aluminium cresfinex MK3 wall end cap	<b>M</b>	Aluminium hip cover cap end cap
<b>E</b>	Capex 40 or 60 wall flashing profile with cover cap	<b>N</b>	Jackcap 40 or 60
<b>F</b>	Cresfinex MK3 ridge	<b>O</b>	Cresfinex MK3 boss (option 1)
<b>G</b>	CFX/BDG 40 or 60	<b>P</b>	CFX MK3 finial base
<b>H</b>	Ankorglaze with or without condensation control	<b>Q</b>	CFX MK3 REC
<b>I</b>	Capex 40 or 60 with cover cap		

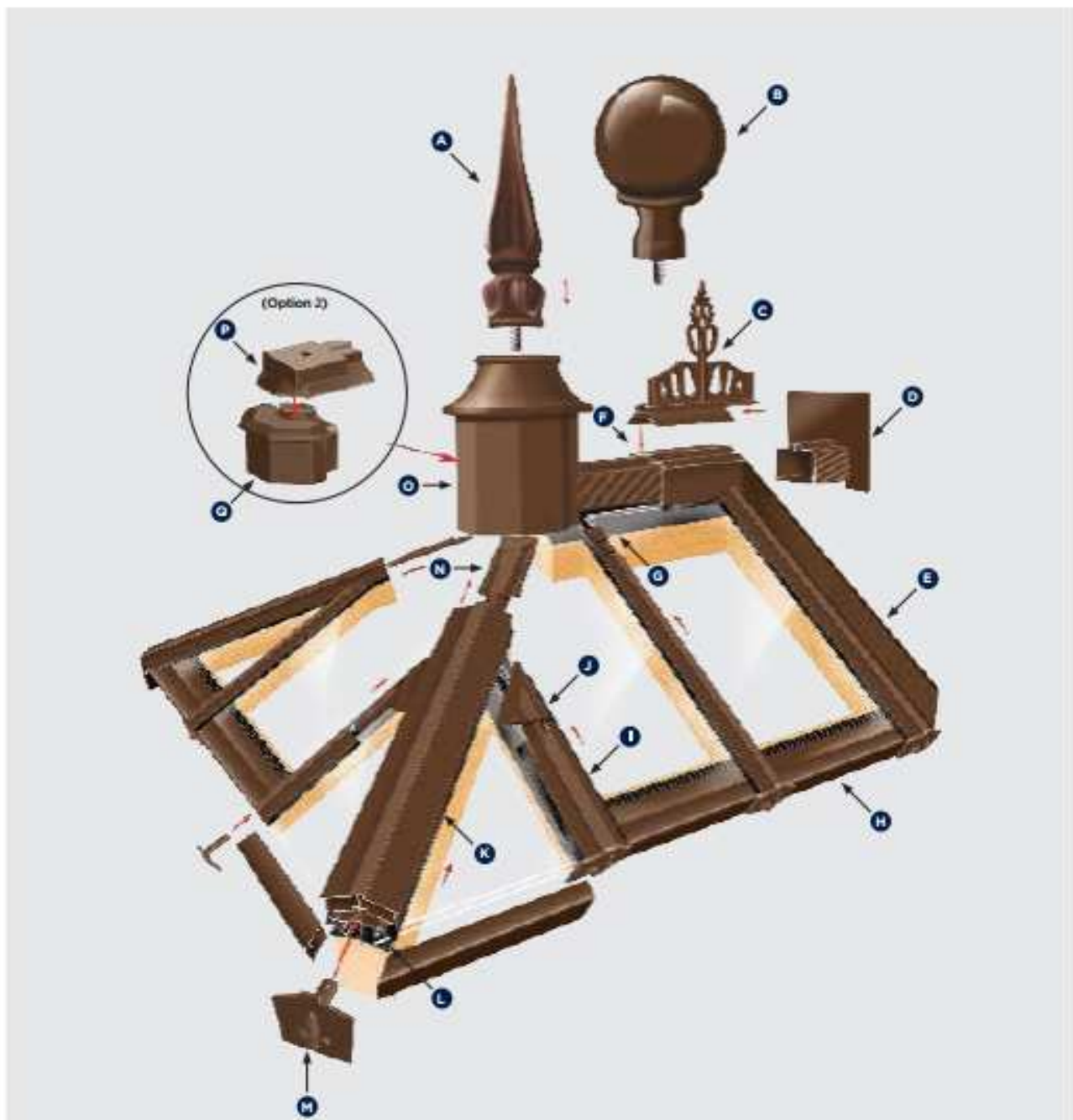



# Cresfinex

## Ridges

### Cresfinex 100mm M2 ridge

For roof pitches 15° - 35°

For over 35° and up to 50° fit hip & valley gasket

Available in 2.4, 3, 4.8 & 6m

Colours - Wh Ral 9010, Bn Ral 8040, Mill Finish

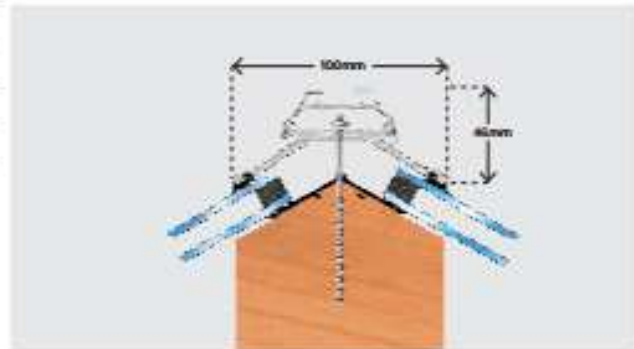

### Cresfinex 175mm M2 ridge

For roof pitches 15° - 35°

For over 35° and up to 50° fit hip & valley gasket

Available in 2.4, 3, 4.8 & 6m

Colours - Wh Ral 9010, Bn Ral 8040, Mill Finish

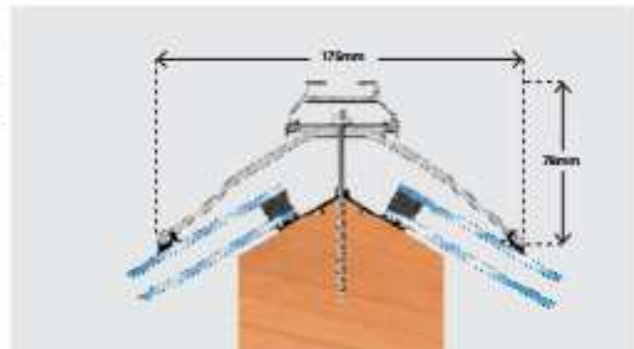

### Cresfinex MK4 ridge

**A** For roof pitches 35° - 50° fit DGBS to internal groove

**B** For roof pitches 15° - 35° fit DGBS to external groove

Available in 2.4, 3, 4.8 & 6m

Colours - Wh Ral 9010, Bn Ral 8040, Mill Finish

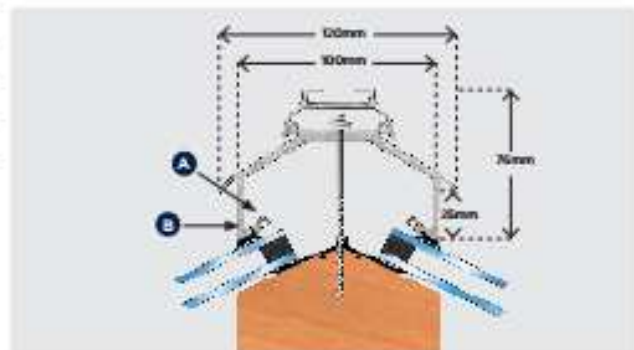

### Cresfinex MK3 ridge

**A** For roof pitches 35° - 50° fit DGBS to internal groove

**B** For roof pitches 15° - 35° fit DGBS to external groove

Available in 3 & 6m

Colours - Wh Ral 9010, Bn Ral 8040, Mill Finish

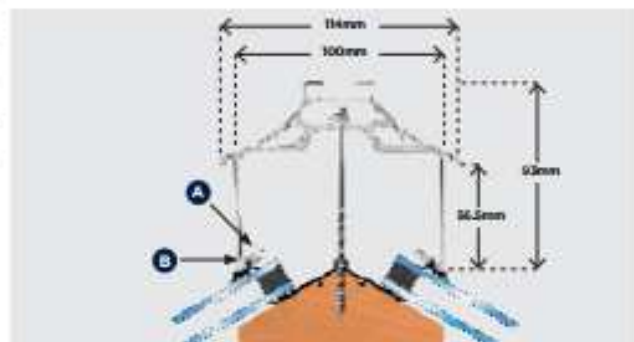

## Ankorglaze for glass retention

Ref: AKG

Available in 2.1 metres

**A** Roof glazing end closure

**B** Glazing anchoring profile

**1** Set top of ring beam level with top of rafter

**2** Fit glazing anchoring profile to ring beam between rafters

**3** Cut roof glazing end closure 10mm wider than glass

Available for 6.4mm, 16mm, 20mm, 25mm, 28mm, 32mm & 35mm double glazing units

Colours - Wh Ral 9010, Bn Ral 8040, Mill Finish

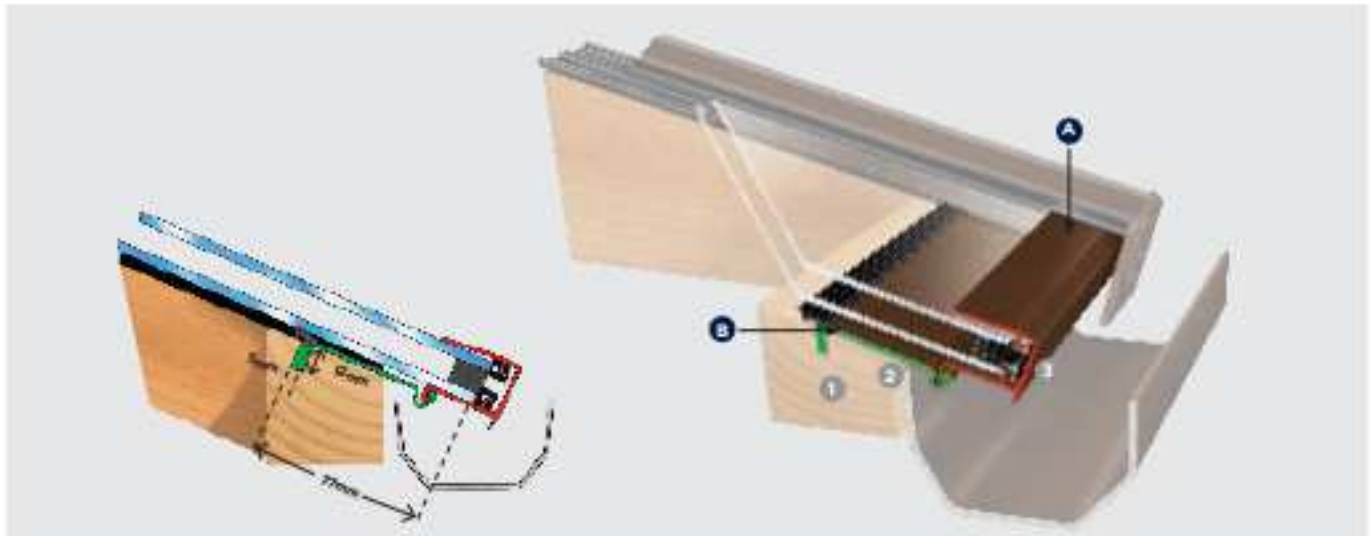

## Ankorglaze with condensation control for glass retention

Ref: AKG/CC

Available in 2.1 metres

**A** Roof glazing end closure

**B** Glazing anchoring profile

**1** Set top of ring beam 10mm below top of rafter

**2** Fit glazing anchoring profile to ring beam between rafters

**3** Cut roof glazing end closure 10mm wider than glass

**4** If drainage is required drill a 5mm hole in channel of glazing anchoring profile

Available for 6.4mm, 16mm, 20mm, 25mm, 28mm, 32mm & 35mm double glazing units

Colours - Wh Ral 9010, Bn Ral 8040, Mill Finish

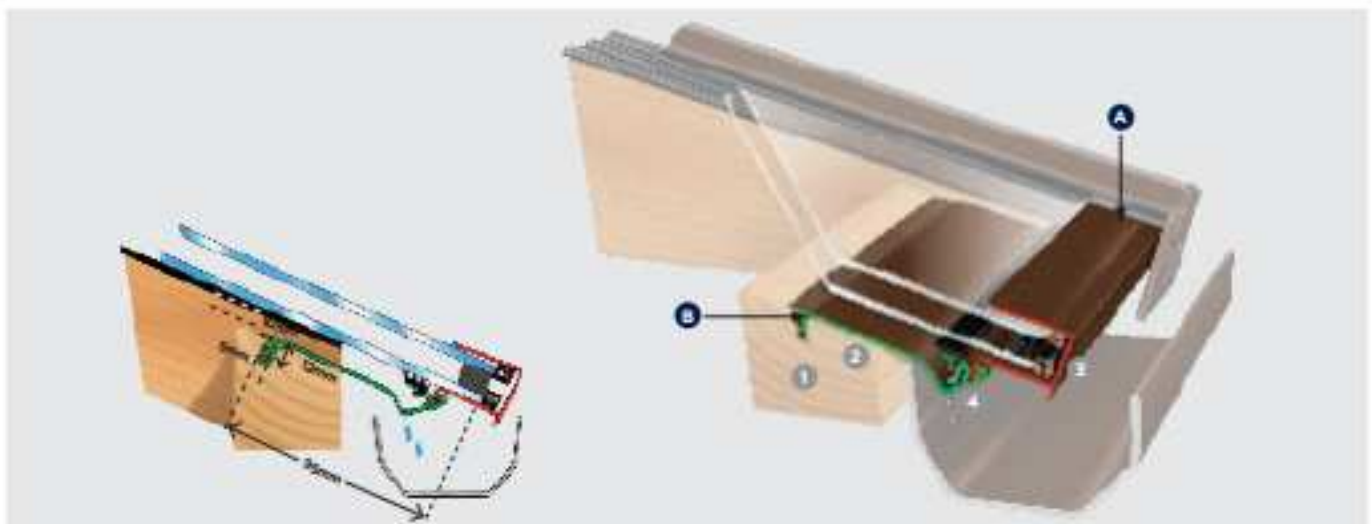

# Horizontal Glazing Bar

## Horizontal glazing bar

<b>A</b> HGB	For double glazing 16mm - 24mm Ref: HGB/16-24
<b>B</b> Rafter	For double glazing 25mm - 32mm Ref: HGB/25-32
<b>C</b> Rafter gasket	



## Horizontal glazing bar for over transoms

<b>A</b> Soft Cushion Profile
<b>B</b> Thermal Break
<b>C</b> Transom
Thermally broken
Available in 3metres

## Self supporting horizontal glazing bar

Self supporting up to 1 metre Ref: HGB/55
Thermally broken

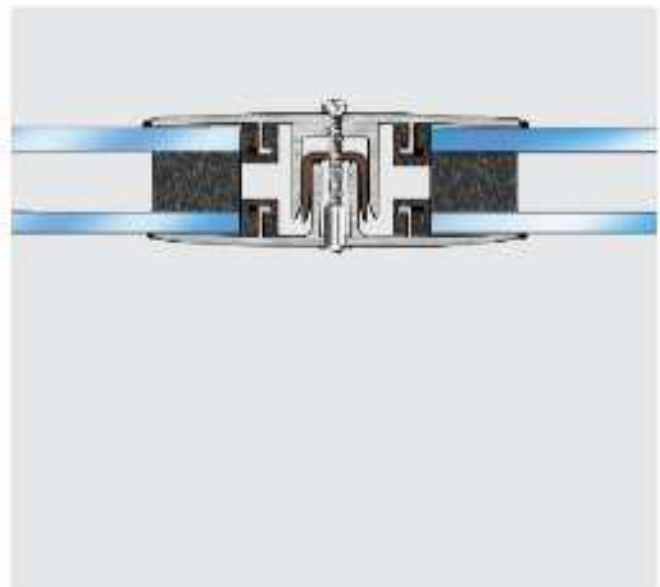
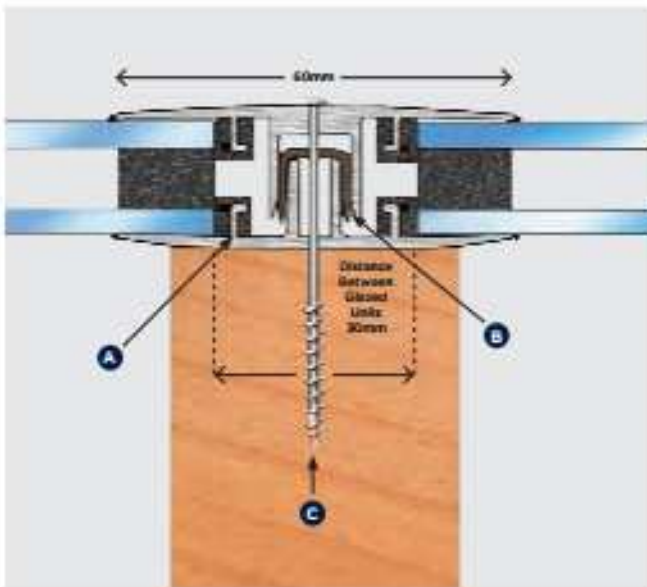



# Valleys

## Adjustable valley

**A** Val A

In 3 & 6 metres

**B** Val B

Available for 6.4mm laminate and 16mm, 20mm, 25mm, 28mm, 32mm & 35mm double glazing units.

Colours - Wh Ral 9010, Bn Ral 8040, Mill Finish

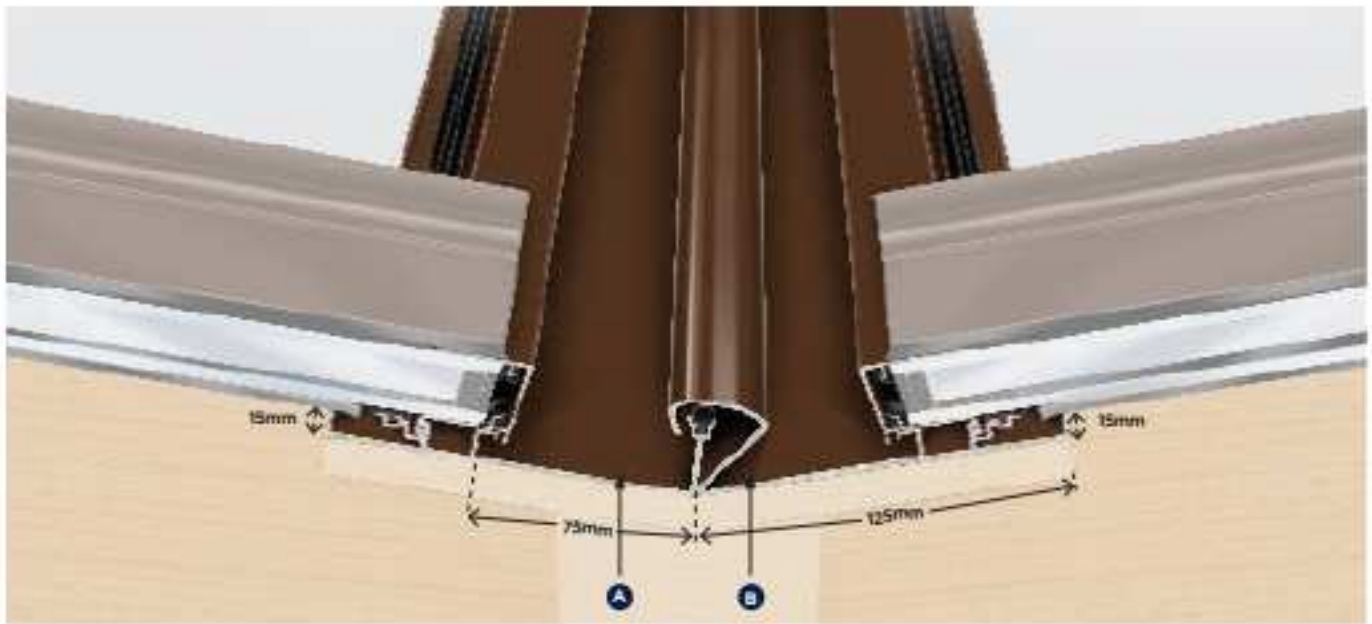

## Compact valley

**A** Val A

In 3 & 6 metres

**B** Val B

Available for 25mm double glazing units



# Additional Components

## PVC roof sheeting enclosures

PVC roof sheeting enclosures in 2.1m

For 10mm, 16mm, 20mm, 25mm, 32mm & 40mm sheeting



## F-sections

Aluminium F-section in 3m, 4m, 5m & 6m

For 10mm, 16mm, 20mm, 25mm, 32mm & 35mm sheeting

PVC F-section in 3m & 4m

For 10mm, 16mm & 25mm sheeting



## Aluminium roof sheeting enclosures

Aluminium roof sheeting enclosures in 2.1m

For 6.4mm, 10mm, 16mm, 20mm, 25mm, 28mm, 32mm & 35mm sheeting



## Lean to flashing profile

For roof pitches 5° - 45°

Suitable for capex 50, 70, 40, 60 & capex snap down

Available in 3 & 6 metres

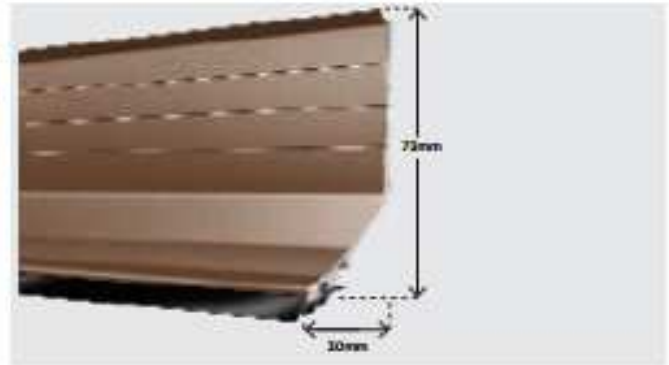

## Cresfinex MK3 Boss

1.05.0360

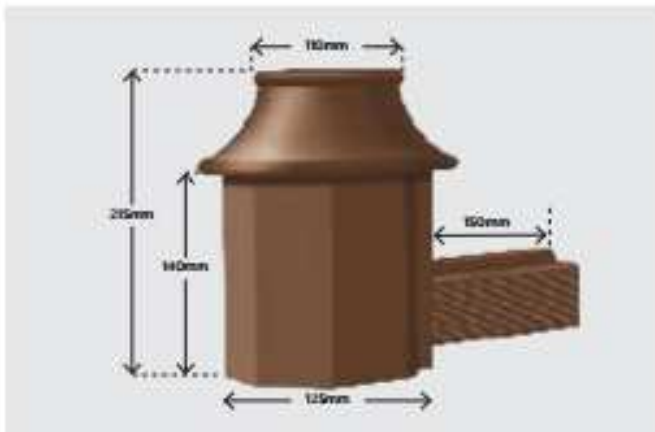

## Cresfinex MK3 gable end boss

1.05.0361

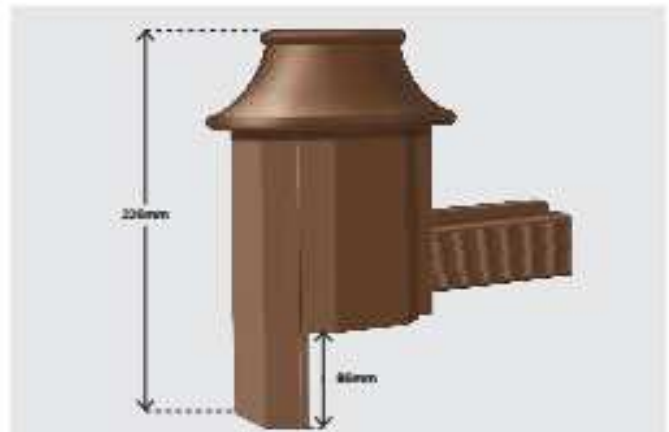

# Capex & Cresfinex Components

## Aluminium ball finials

**A** Ref: BALL/F/80

H 130 x D 80

105.0380

**B** Ref: BALL/F/125

H 180 x D 125

105.0385



## Aluminium Finials & uPVC Finials

**A** Ref: FDL/CA/F

H 350

105.0201

**B** Ref: TULIP/F

H 350

105.0366

**C** Ref: CFX/M2/PF

H 350

105.0015



## Bolt down aluminium balls finials

**A** Ref: BALL/BD/F/125

H 180 x D 125

105.0370

**B** Ref: BALL/BD/F/85

H 190 x D 85

105.0375



## Bolt down aluminium finials

**A** Ref: TULIP/BD/F

H 320

105.0365

**B** Ref: SPIRE/BD/F

H 320

105.0050





## Capex & Cresfinex Components

### Aluminium victorian crest

Ref: V/CA

L 300 x H 160

1.05.0204

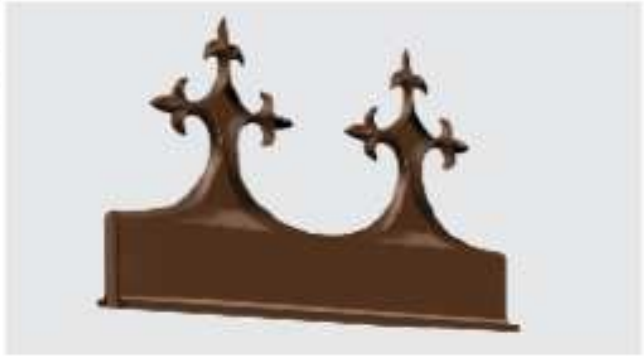

### Aluminium fleur de lys crest

Ref: FDL/CA

L 300 x H 210

1.05.0200



### Aluminium antique crest

Ref: AT/CA

L 500 x H 130

1.05.0055



### uPVC antique crest

Ref: AT/C

L 235 x H 115

1.05.0001



# Capex & Cresfinex Components

<b>A</b>	Regency
	Ref: CFXCR/6
	L 143 x H 150
	Ref: CFXCR/8
	L 143 x H 200
<b>B</b>	Fleur de lys
	Ref: FDL/C
	L 143 x H 224



## CFX MK2/MK4 aluminium wall end cap

Ref: WEC
1.05.0019



## CFX MK3 finial base & REC

<b>A</b>	Ref: CFX M3 finial base
	1.05.0275
<b>B</b>	Ref: CFX MK3 REC
	1.05.0276



## Aluminium CFX connectors

Available for MK2, MK3 and MK4 ridge	
<b>A</b>	90° Connector
<b>B</b>	Connector
<b>C</b>	T Connector
<b>D</b>	Cross Connector

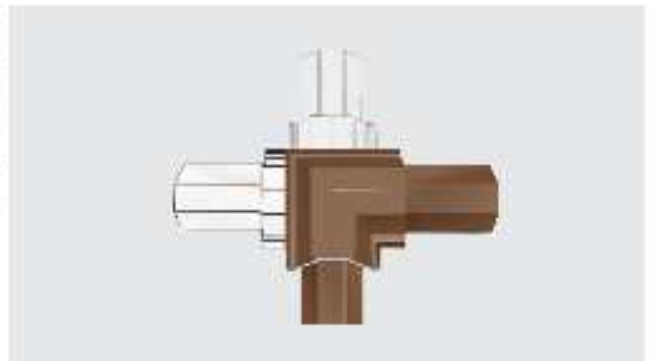

# Capex & Cresfinex Components

## Capex uPVC extended end caps

**A** Ref: CAP/40/EEC  
104.0570.0040

**B** Ref: CAP/60/EEC  
104.0570.0060



## Jack caps 40 & 60

**A** Ref: JC/40  
105.0570.0040

**B** Ref: JC/60  
105.0570.0060



## Cresfinex 40 & 60 HV bridgings

**A** Ref: BDGHV 40  
Ref: BDGHV 60  
For 20°- 40°

**B** Ref: BDGHV 40/45  
Ref: BDGHV 60/45  
For 45°- 75°



## Cresfinex 40 & 60 bridgings

**A** Ref: CFX/40/BDG  
105.0031

**B** Ref: CFX/60/BDG  
105.0032





# Capex & Cresfinex Components

## Aluminium MK2/MK4 cap end cap

When not fitting finials

105.0207



## Cresfinex MK2 radius end caps

**A** Ref: CFX/100/REC

105.0045

**B** Ref: CFX/175/REC

105.0065



## Cresfinex MK2 & MK4 gable end caps

**A** Ref: CFX/MK2/GEC

105.0205

**B** Ref: CFX/MK4/GEC

105.0203



## Cresfinex MK4 radius end cap

Ref: CFX/MK4/REC

105.0430



# Capex & Cresfinex Components

## Aluminium extended end caps

**A** Ref: CAP/50/A/EEC

1.04.0353

**B** Ref: CAP/70/A/EEC

1.04.0354



## Hip jack cap 70

Ref: H/JC/70

1.05.0557



## Cresfinex 50 & 70 bridgings

**A** Ref: CFX/BDG/50

1.05.0035

**B** Ref: CFX/BDG/70

1.05.0036



## Hip bridgings 50 & 70

**A** Ref: CFX/H/BDG70

1.05.0555

**B** Ref: CFX/H/BDG50

1.05.0554



# Gaskets, Accessories & Elast-O-Sealant

## Rafter gasket 45mm

<b>A</b>	Ref: RAG/45
	1.09.0045
<b>B</b>	Groove located ref: RAG/45/GL
	1.09.0145
	Available in black 100m rolls

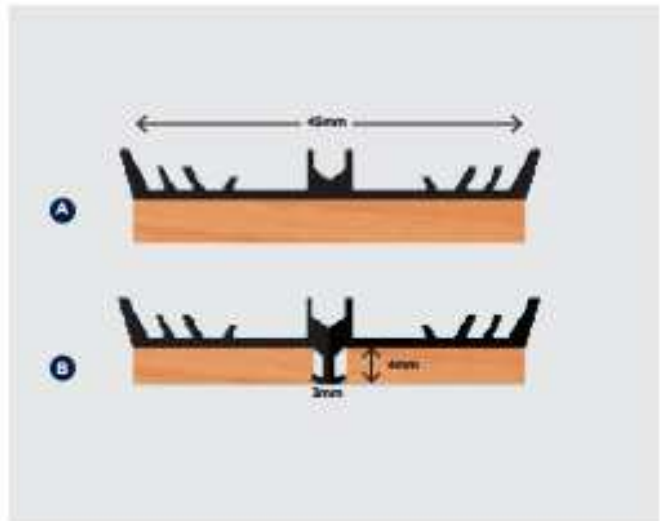

## Rafter gasket 55mm

<b>A</b>	Ref: RAG/55
	1.09.0055 100m rolls
<b>B</b>	Groove located ref: RAG/55/GL
	1.09.0155 100m rolls
<b>C</b>	Twin groove ref: RAG/55/TG
	1.09.0257
	Available in black 50m rolls

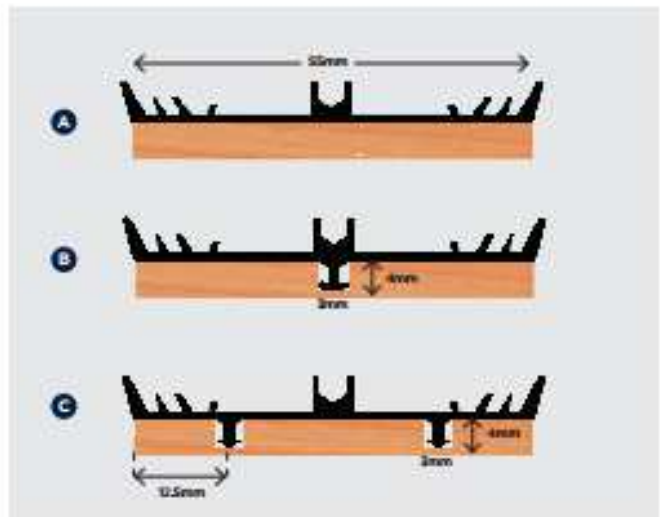

## Rafter gasket 77mm

	Triple groove ref: RAG/77/TG
	1.09.0277
	Available in black 50m rolls

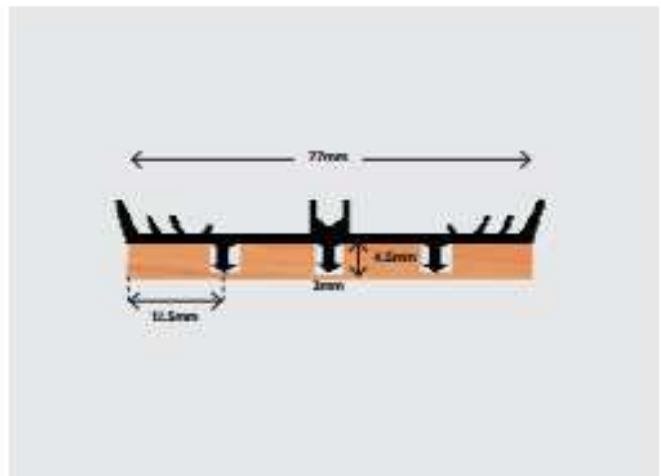



# Gaskets, Accessories & Elast-O-Sealant

## Hip & valley gasket

Ref: HSV

109.0300

Available in black 30m rolls

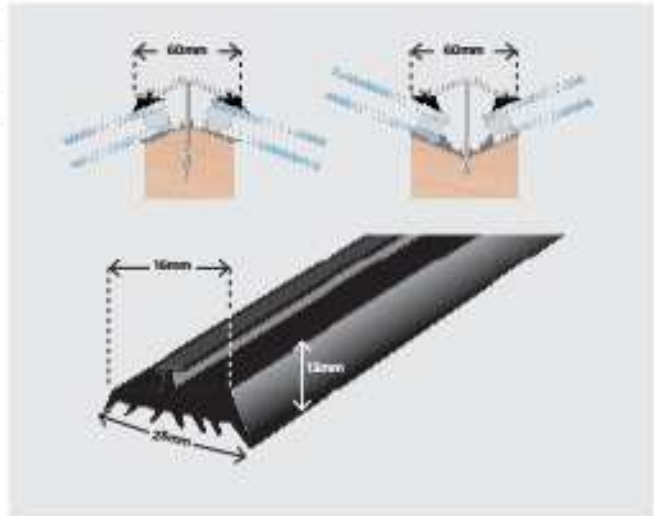

## Push fit gaskets

**A** Ref: DGB5/AS 3 x 15

109.0020

For capex & CFX

**B** Ref: DGB5/RT 2 x 12

109.0025

For inside groove of flashing & finishing profiles

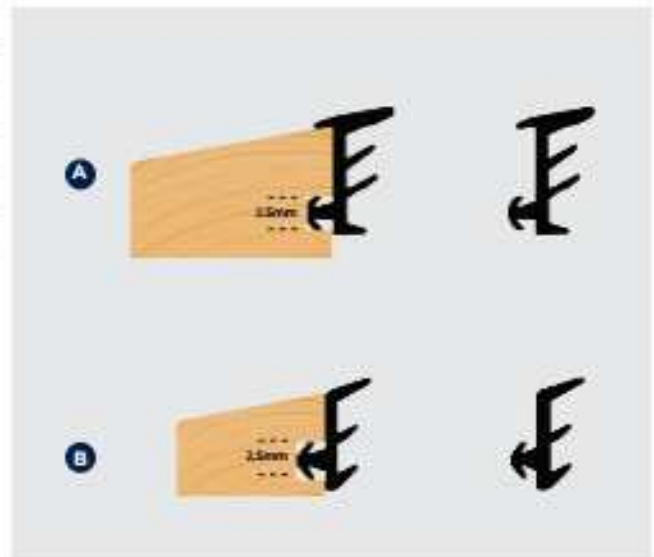

## Expandex foam

Expandex foam x 6.6m

Expands from 5 = 25mm

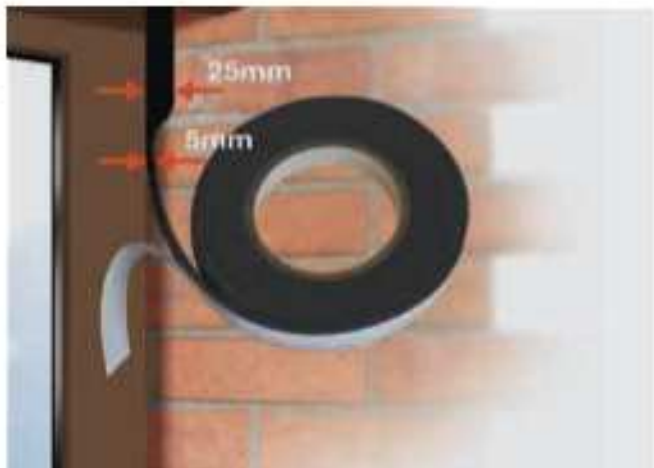

## Gaskets, Accessories & Elast-O-Sealant

### Butyl flashtex

---

Butyl flashtex x 10m

---

In widths of 6" & 8"

---

Colours - white/lead

---



### Sheet anchoring devices

---

Sheet anchoring devices

---

For 10mm, 16mm, 20mm, 25mm & 32mm poly

---



### Elast-O-Sealant

---

Elast-O-Sealant is recommended for use with capex & crestfinex, can be applied to wet or dry surfaces, over painted and is compatible with Pilkington Activ™ Glass and lead.

Available in black, brown, white, grey & clear



# Capex Snap Down

## Capex snap down

**A** F section

**B** Capex snap down upper UPVC

**C** Lean to finishing profile

**D** CSD bridging piece

**E** Extended end cap

**F** Roof sheeting end closure

**G** Snap down universal gable end finishing profile

Available in brown & white

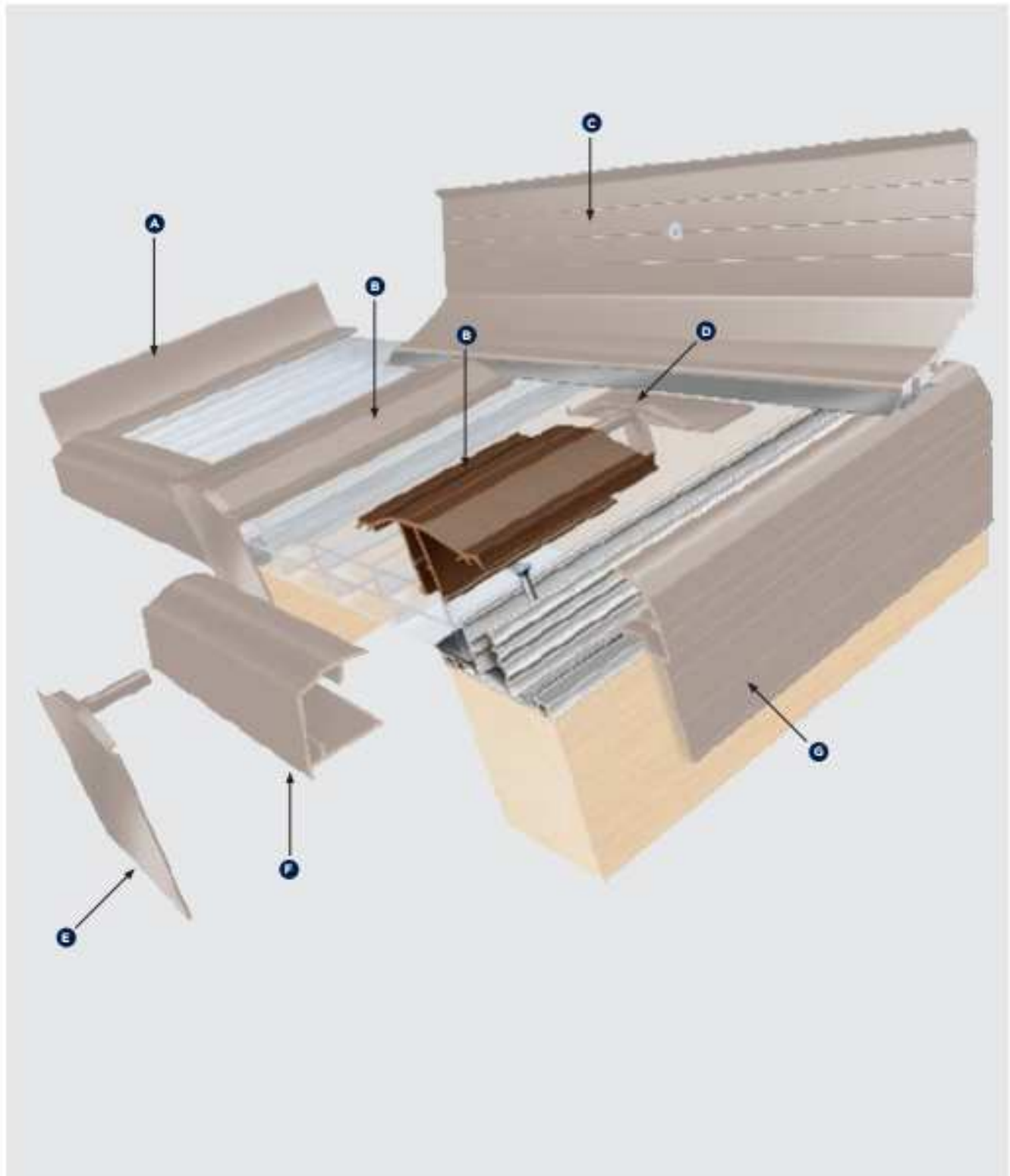



# Capex Snap Down

## Capex snap down 10 - 25

Capex snap down 10 - 25 for glazing materials 10 - 25mm

Ref: CSD/10-25

104.0700

Available in 2, 2.5, 3, 4, 5 & 6 metres

Colours - Wh Ral 9010, Bn Ral 8040

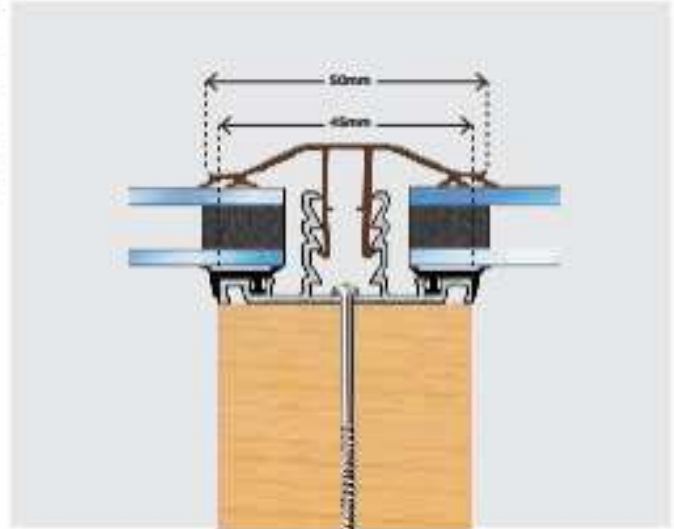

## Capex snap down 25 - 32

Capex snap down 25 - 32 for glazing materials 25 - 32mm

Ref: CSD/25-32

104.0800

Available in 2, 2.5, 3, 4, 5 & 6 metres

Colours - Wh Ral 9010, Bn Ral 8040

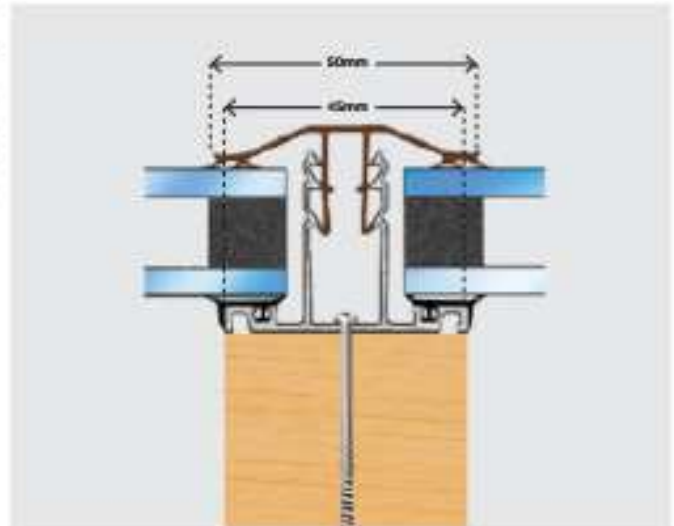

## Gable end finishing profile

Gable end finishing profile for glazing materials 10 - 25mm

Ref: CSD/GEF

104.0710

Available in 2, 2.5, 3, 4, 5 & 6 metres

Colours - Wh Ral 9010, Bn Ral 8040

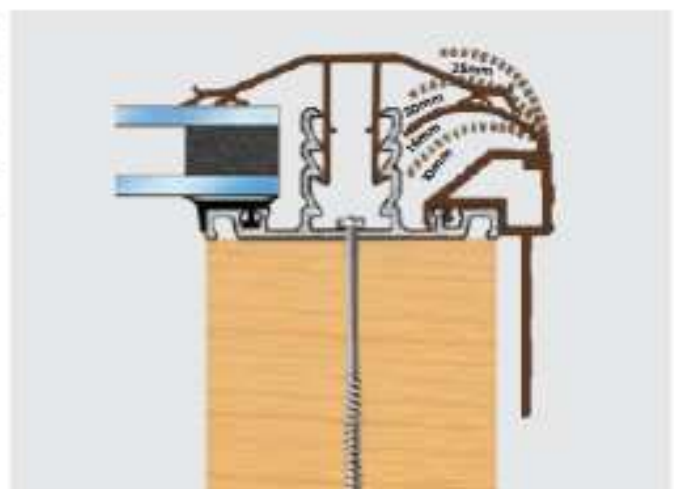

Bay Plastics Ltd  
Unit H1 High Flatworth  
Tyne Tunnel Trading Estate  
North Shields  
Tyne & Wear  
NE29 7UZ  
Tel: +44 (0) 191 258 0777  
Fax: +44 (0) 191 258 1010  
Email: [sales@bayplastics.co.uk](mailto:sales@bayplastics.co.uk)